

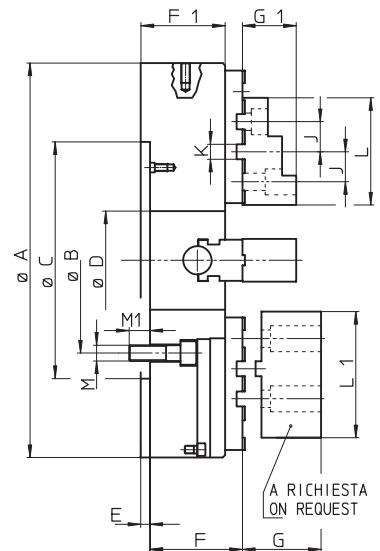

• Corpo in acciaio
Steel body

• Griffe in 2 pezzi
2-piece jaws

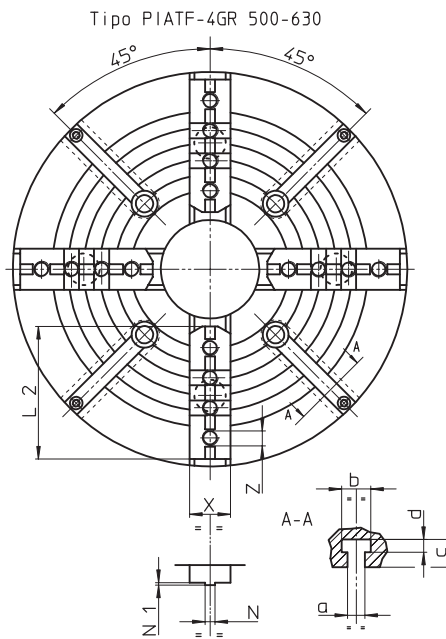
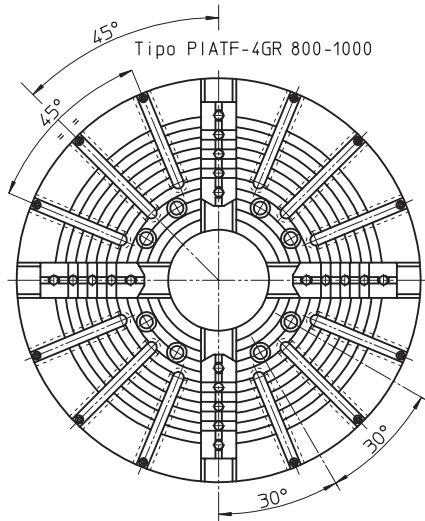

Soggetto a cambiamenti tecnici / Subject to technical changes

MPT tipo PIATF-4GR		500	630	800	1000
Attacco/Mounting	DIM	FL300	FL300	FL380	FL520
	A	500	630	800	1000
	B	235	235	330,2	463,6
	C (H4)	300	300	380	520
	D	125	160	200	190
	E	12	12	12	12
	F	117,1	137,1	147,1	155,1
	F1	107	127	147	155
	G	75,7	75,7	75,7	75,7
	G1	68,2	75,7	81,7	90,7
	J ±0,1	38,1	38,1	38,1	38,1
	K +0,01	19,04	19,04	19,04	19,04
	L	136	136	136	136
	L1	160	160	160	160
	L2	168	206	206	244
	M	4xM20	4xM20	8xM24	8xM24
M1	26,5	31,5	30,5	31	
N -0,03	12,7	12,7	12,7	12,7	
N1	3,2	3,2	3,2	3,2	
Chiave/Key	QUADRO	17	19	19	19
	X (h6)	52	52	70	70
	Z	M20	M20	M20	M20
	a (H10)	22	22	22	28
	b +3	37	37	37	43
	c	35	35	35	41
	d +2	16	16	16	20
Velocità max./Max speed *	r.p.m.	700	550	450	300
Coppia/Torque M max	N.m	140	160	300	320
Massa con gr./Weight (w. jaws)	Kg	150	300	550	800
Mom. d'inerzia/Mom. of inertia	Kgm ²	4,7	14,9	44	100
Diametro presa Min/Max Min/Max Clamping diameter	mm	ø 45 / 550	ø 50 / 650	ø 50 / 850	ø 100 / 1050
Codice d'ordine/Ordering example		33037550	33037563	33037580	33037590
A RICHIESTA ON REQUEST	 Set-4 bloc. teneri/Soft jaws	03605040	03606340	03606340	03609040

Dotazione standard:
1 Set-4 false griffe
1 Set-4 griffe reversibili

Standard equipment:
1 Set of 4 master jaws
1 Set of 4 reversible jaws

* Valide con pezzo bloccato perfettamente bilanciato
With clamped workpiece perfectly balanced

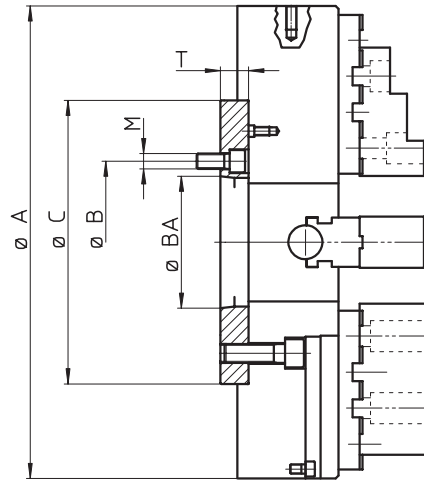
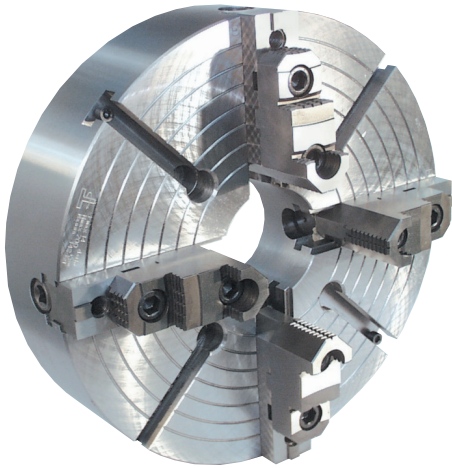

Tipo 2
montaggio ISO-A di riduzione
reduction ISO-A mounting

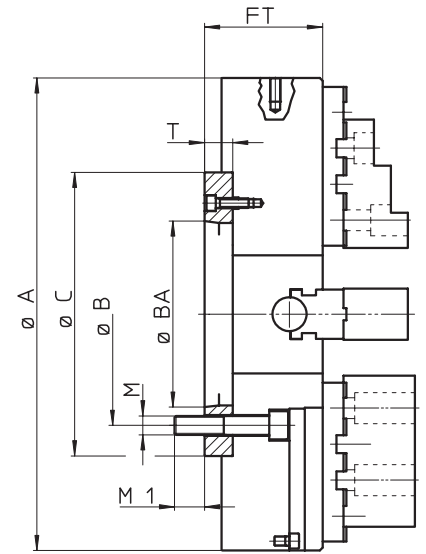

Tipo 1
montaggio ISO-A diretto
direct ISO-A mounting

Soggetto a cambiamenti tecnici / Subject to technical changes

Flange montaggio ISO-A tipo 1 diretto / Direct ISO-A mounting - type 1

Flangia/Adapter cod.	Naso macch./mtg.	A	B	BA	C	M	M1	T	FT
24113110	A11	500	235	196,869	300	N° 4-M20x100 N° 4-M20x120	31,5	30	125
		630							145
24127100	A15	800	330,2	285,775	380	N° 8-M24x180	37,5	33	168
24178000	A20	1000	463,6	412,775	520				

Flange montaggio ISO-A tipo 2 di riduzione / Reduction ISO-A mounting - type 2

Flangia/Adapter cod.	Naso macch./mtg.	A	B	BA	C	M	M1
24163100	A6	500-630	133,4	106,375	300	M12	30
24183100	A8		171,4	139,719			
24185000	A8	800	235	196,869	380	M20	40
24115000	A11						
24116100	A11	1000	330,2	285,775	520	M24	
24126100	A15						

MPT tipo PIATF-4GR / MPT 4 jaw independent chuck

	500	630	800	1000
Set-4 false griffe/Master jaws	03575070	03576370	03578070	03579070
Set-4 griffe reversibili/Rev. jaws	03636370		03638070	03639070
Set-4 bloc.teneri/soft jaws	03605040	03606340	03606340	03609040
Vite serraggio/Screw	03705070	03706370	03708070	03709070
Forc. di ritegno/Check fork	03675070	03676370	03678070	03679070
Chiave di sicurezza/Safety wrench	02714000		02716300	
Grasso/Grease	10731131			
Set-4 griffe integrali reversibili Set-4 one-piece solid reversible jaws	03555070	03556370	03558070	-

RICAMBI/SPARE PARTS