

06045100 - TH-AX D60 C50 RF H90

Type	TH-AX Axial Tool holder
Mounting	CYLINDRICAL SHANK 60
Tool output	Polygonal shank C50 ISO 26623-1
Coolant	Internal coolant
H [mm]	90
Accessories	N.A.
Notes	N.A.
Mounting tips	N.A.

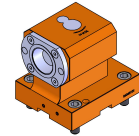

Always check live tool dimensions on the turret

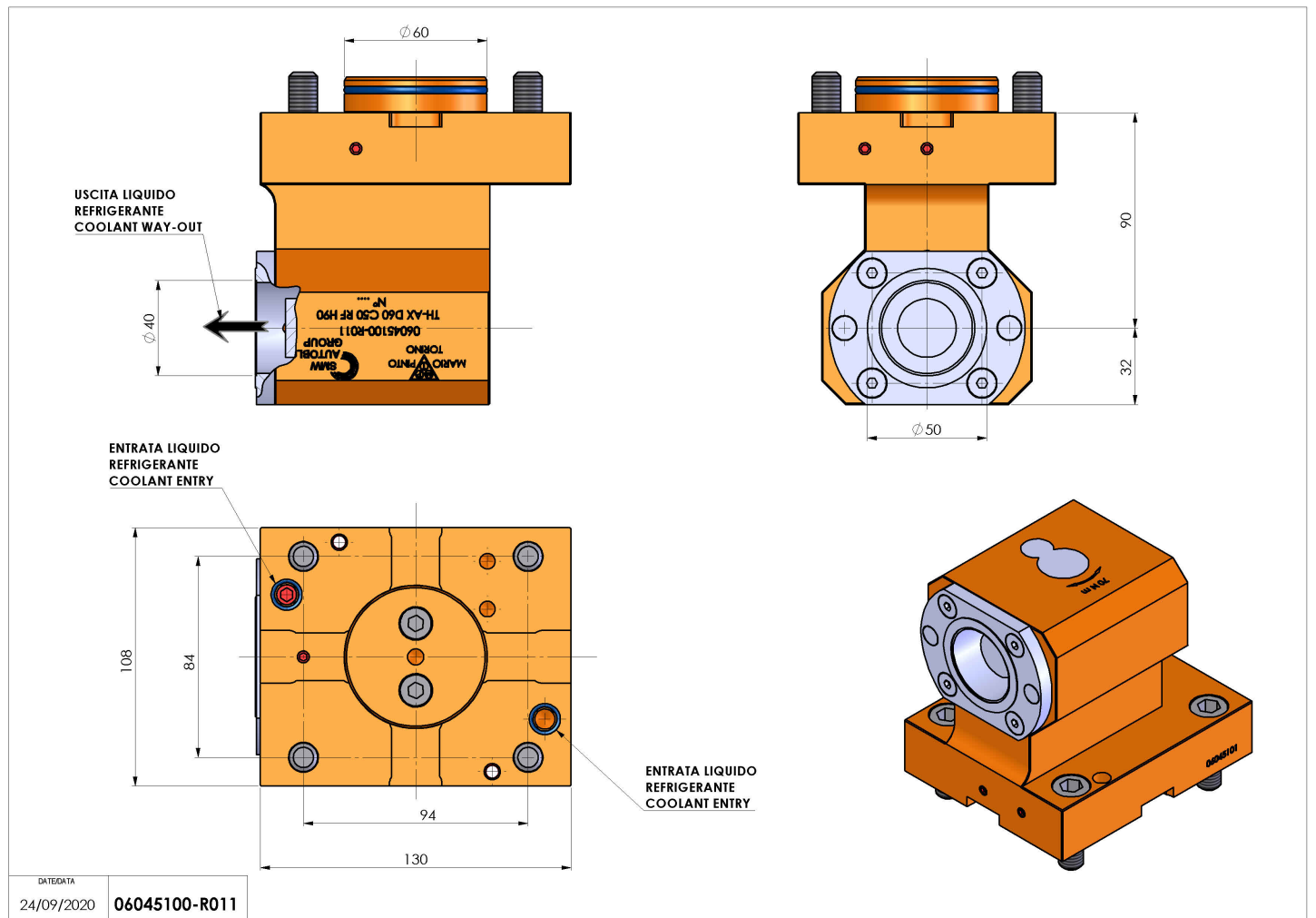

Subject to technical changes