

05121600 - LT-S BMT65 ER32F H60 DW

Type	LT-S Tool holder straight
Mounting	BMT 65
Tool output	Collet nut ER 32 F - internal nut
Coolant	External coolant
Direction of rotation	r1 ↻ r2 ↻
Max speed [rpm]	6000
Max torque [Nm]	70
Ratio	1:1
H [mm]	60
Accessories	
Notes	N.A.
Mounting tips	N.A.

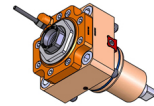

Always check live tool dimensions on the turret

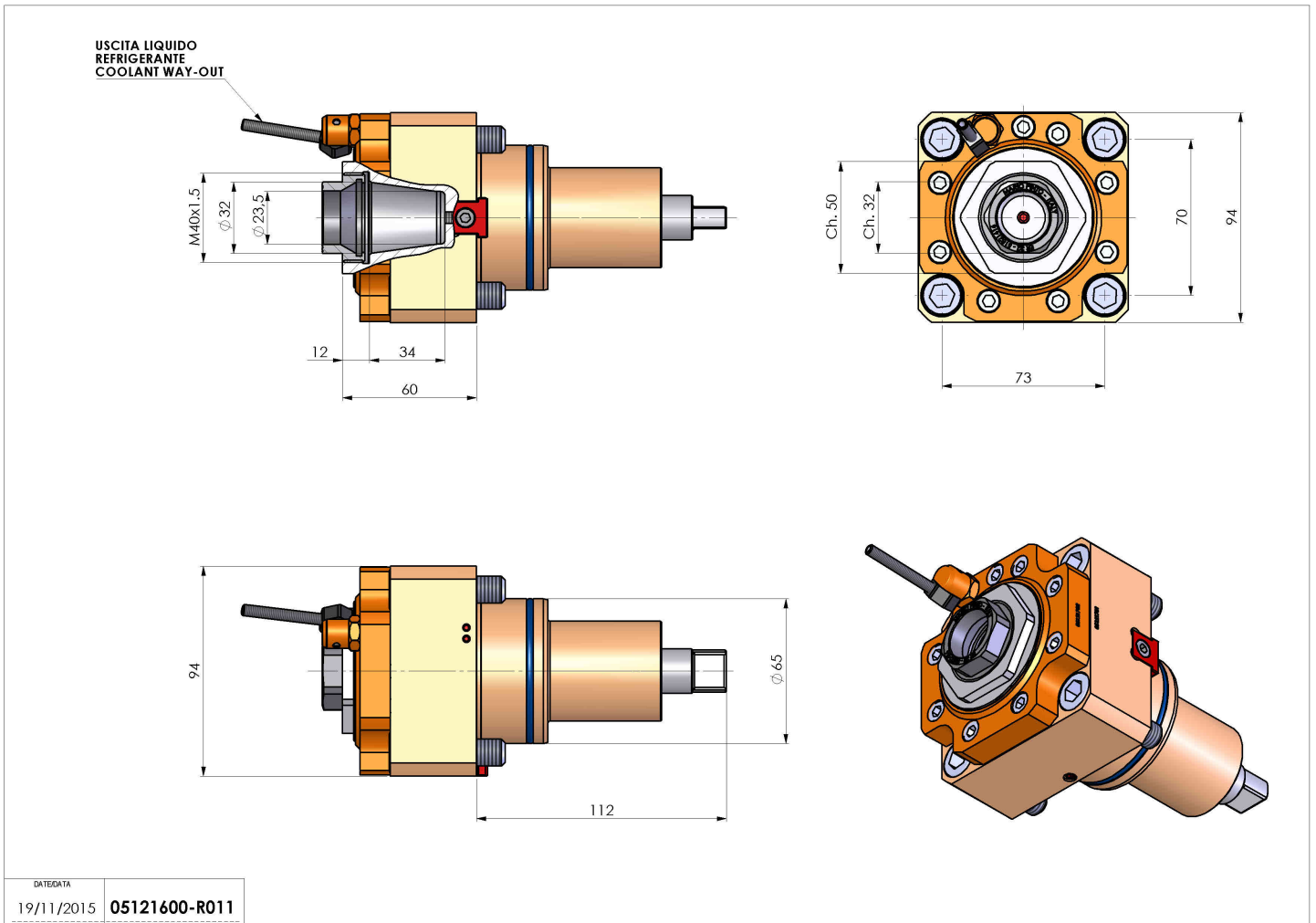

DATE/DATE	05121600-R011
19/11/2015	

Subject to technical changes