

## 05513200 - LT-A BMT65 BD ER32 LR HRF HS H100

<b>Type</b>	LT-A Tool holder angle 90°
<b>Mounting</b>	BMT 65 BIG DRIVE
<b>Tool output</b>	Collet nut ER 32
<b>Coolant</b>	HRF Internal coolant
<b>Direction of rotation</b>	r1  r2
<b>Max speed [rpm]</b>	10000
<b>Max torque [Nm]</b>	63
<b>Ratio</b>	1:1
<b>H [mm]</b>	100
<b>H1 [mm]</b>	38
<b>Max pressure [bar]</b>	80
<b>Accessories</b>	N.A.
<b>Notes</b>	N.A.
<b>Mounting tips</b>	N.A.

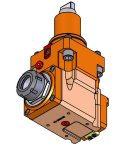

Always check live tool dimensions on the turret

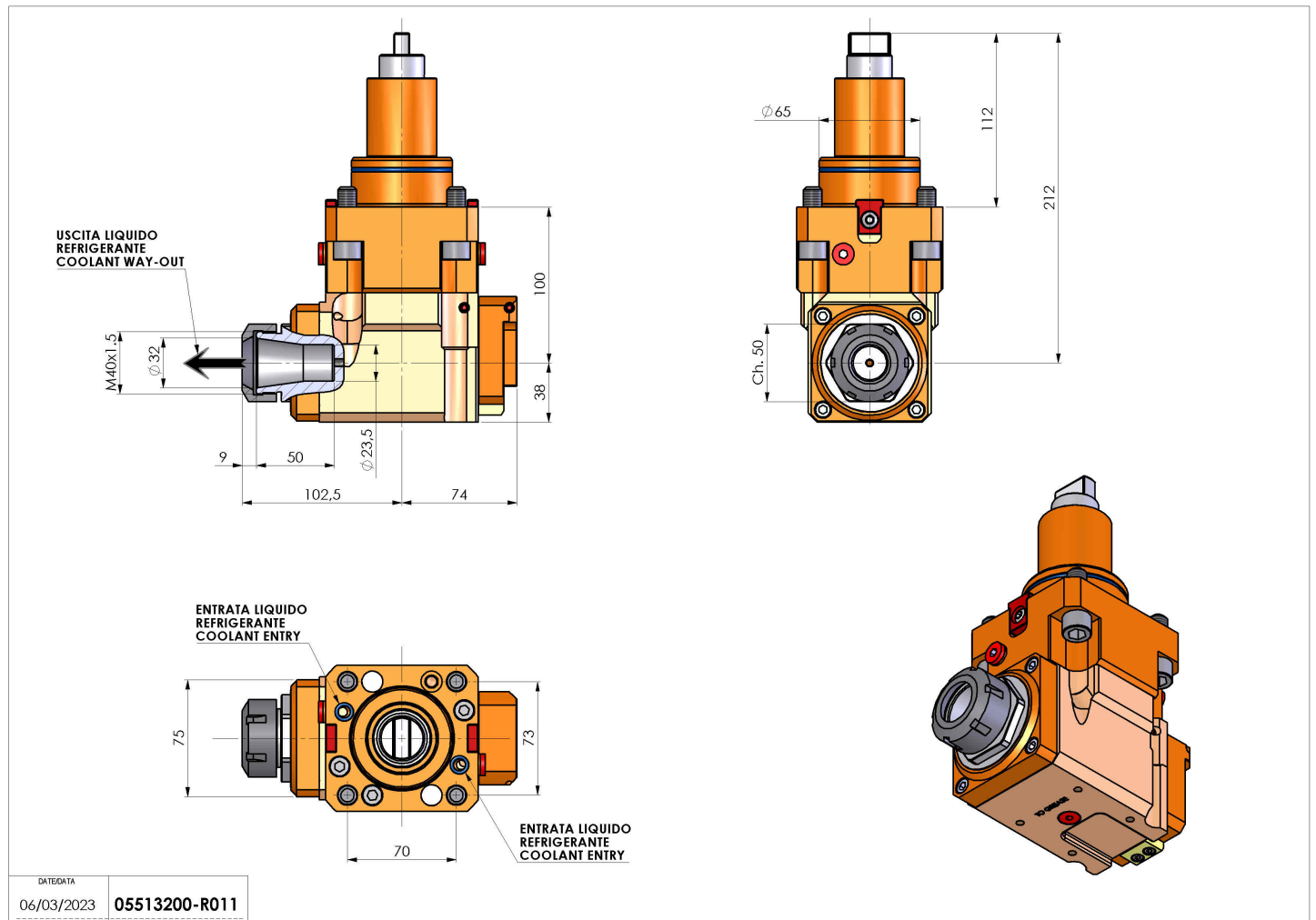

DATE/DATE	06/03/2023
PART NUMBER	05513200-R011

Subject to technical changes