

05161500 - LT-S VDI40M WELDON20 RF H108MU

Type	LT-S Tool holder straight
Mounting	VDI 40
Tool output	Weldon 20 DIN1835B
Coolant	Internal coolant
Direction of rotation	r1 ↻ r2 ↻
Max speed [rpm]	6000
Max torque [Nm]	63
Ratio	1:1
H [mm]	108
Max pressure [bar]	20
Accessories	
Notes	N.A.
Mounting tips	N.A.

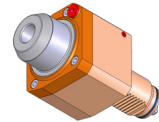

ATTENTION: CHECK THE ORIENTATION OF THE VDI TEETH

Always check live tool dimensions on the turret

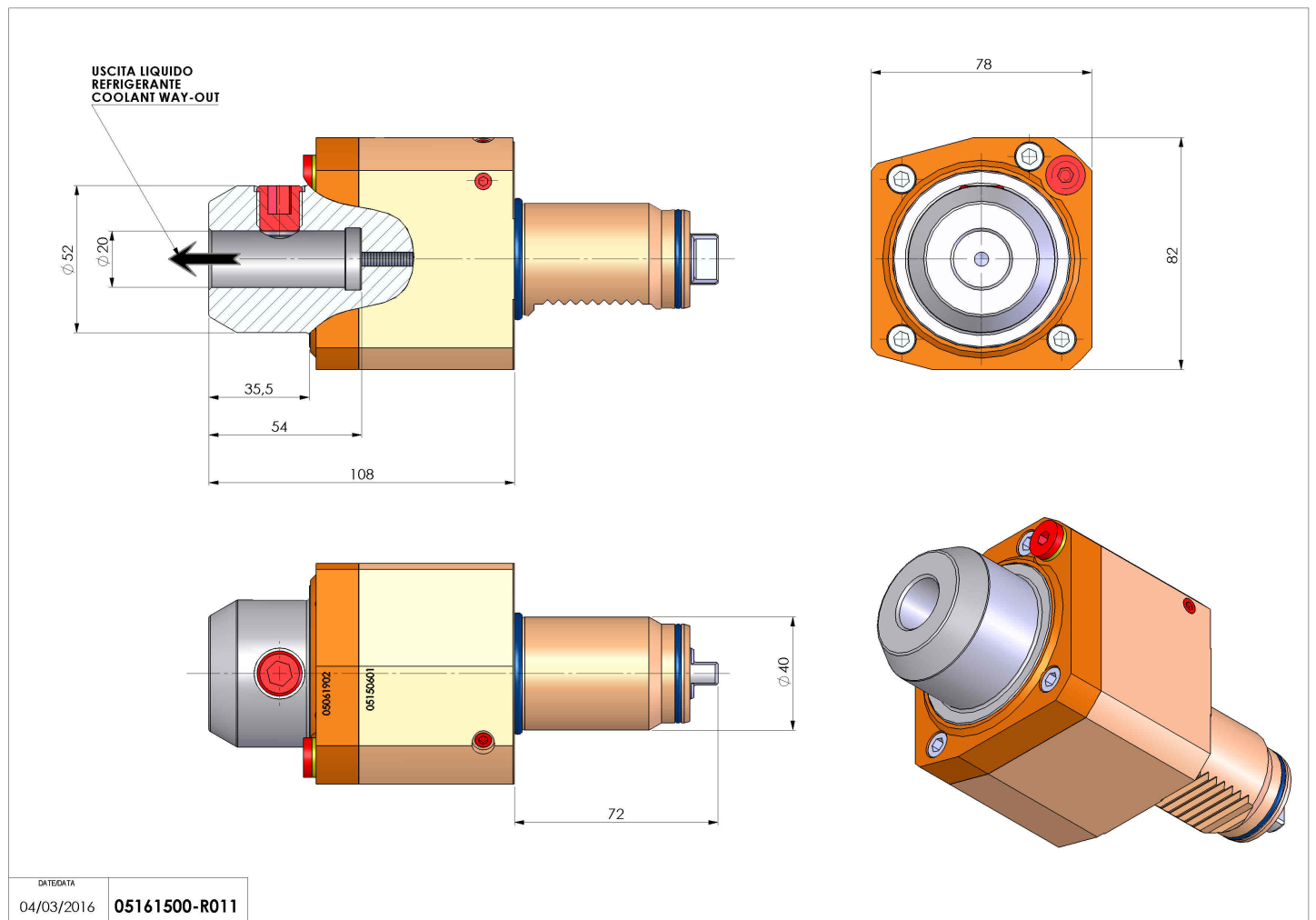

Subject to technical changes